

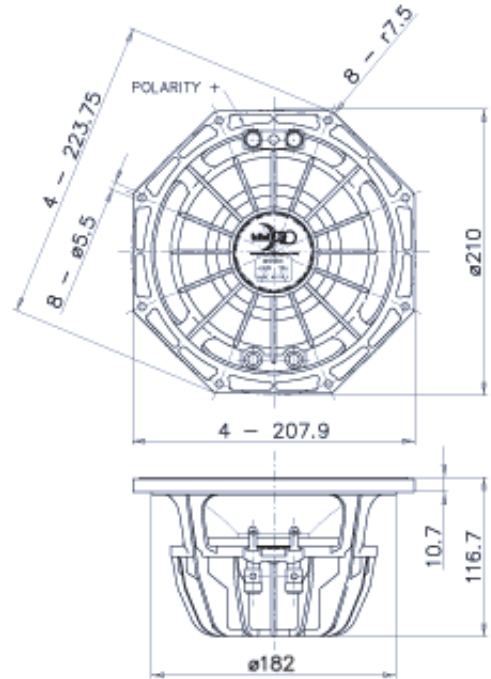

8PR200 Professional Series



NOMINAL SPECIFICATIONS

Nominal Diameter	200 mm (8 in)
Overall Diameter	223.8/203.9 mm (8.81/8.18 in)
Bolt Circle Diameter	210 mm (8.27 in)
Baffle Cutout Diameter	184 mm (7.24 in)
Depth	116.7 mm (4.59 in)
Flange and Gasket Thickness	10.7 mm (0.42 in)
Net Weight	2.1 Kg (4.63 lb)
Shipping Box (Single Carton Box)	235x235x155 mm (9.25x9.25x6.1 in)
Shipping Weight	2.5 Kg (5.51 lb)

ELECTRICAL SPECIFICATION

Nominal Impedance	8 Ohm
Minimum Impedance	6.4 Ohm
AES Power Handling *	200 W
Maximum Power Handling **	400 W
Sensitivity (1W/1m)	95 dB
Frequency Range	70÷5000 Hz
Voice Coil Diameter	52 mm (2 in)
Winding Material	Al
Former Material	Glass Fiber
Winding Depth	19.3 mm (0.76 in)
Magnetic Gap Depth	9 mm (0.35 in)
Flux Density	1.15 T
Magnet	Neodymium Ring
Demodulation	Aluminum Ring
Suspension ***	M-Roll

THIELE & SMALL PARAMETERS

Fs	58 Hz
Re	5.1 Ohm
Qes	0.38
Qms	9.4
Qts	0.36
Vas	15.2 dm ³ (0.54 ft ³)
Sd	196 cm ² (30.4 in ²)
Xmax ****	8.15 mm
Xdamage *****	13.5 mm
Mms	27.2 g
Bl	11.5 N/A
Le	0.55 mH
Mmd	25.6 g
Cms	0.28 mm/N
Rms	1.04 Kg/s
Eta Zero	0.76 %
EBP	153 Hz

NOTES

Spider Profile: 1x variable height waves

(*) 2 Hours Test According to AES 2-1984 Rev. 2003

(**) Maximum power is defined as 3dB greater than nominal power.

(***) Treated Polycotton

(****) $X_{max} = [(winding\ depth - magnetic\ gap\ depth) / 2] + (magnetic\ gap\ depth / 3)$

(*****) Maximum excursion before permanent damage

CURVES

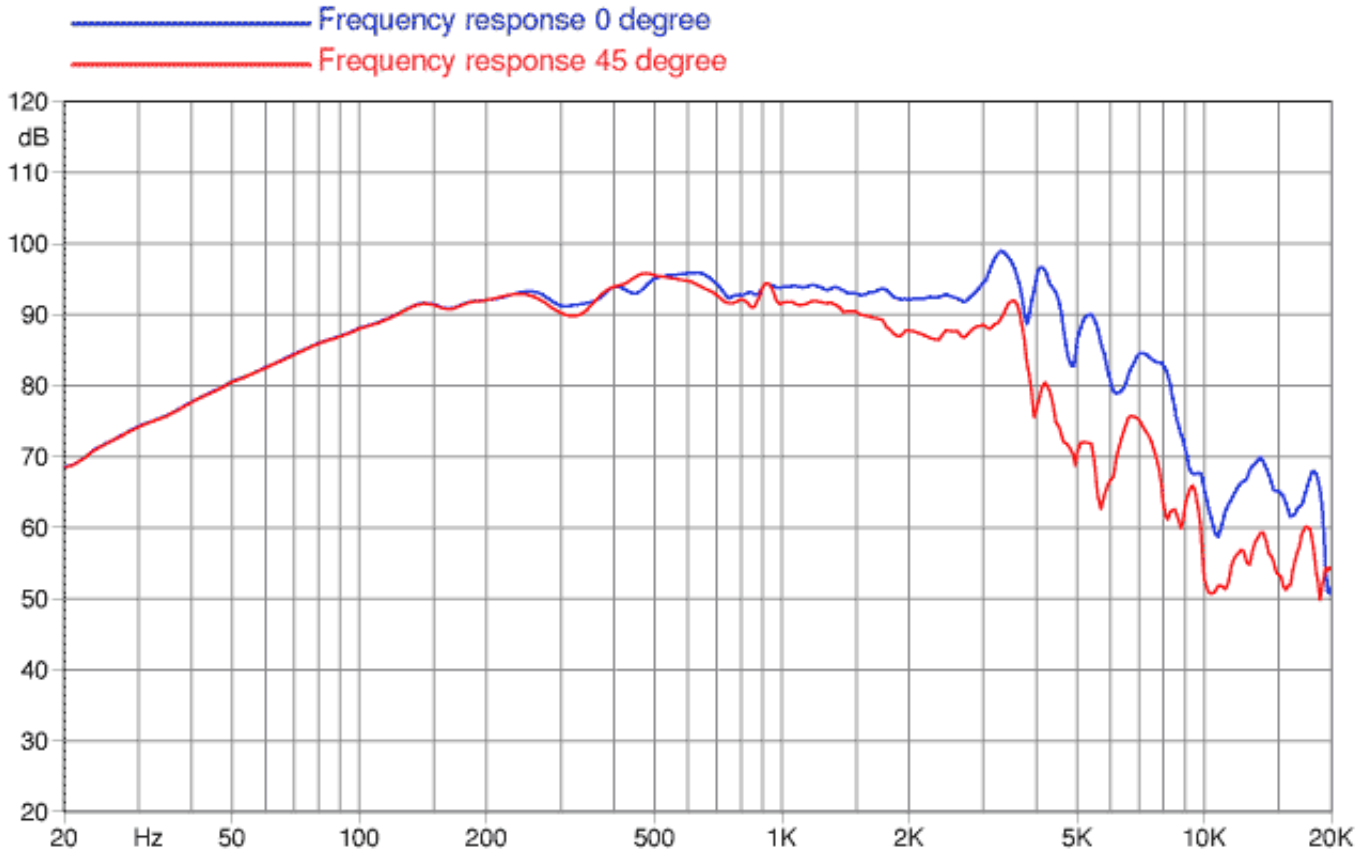

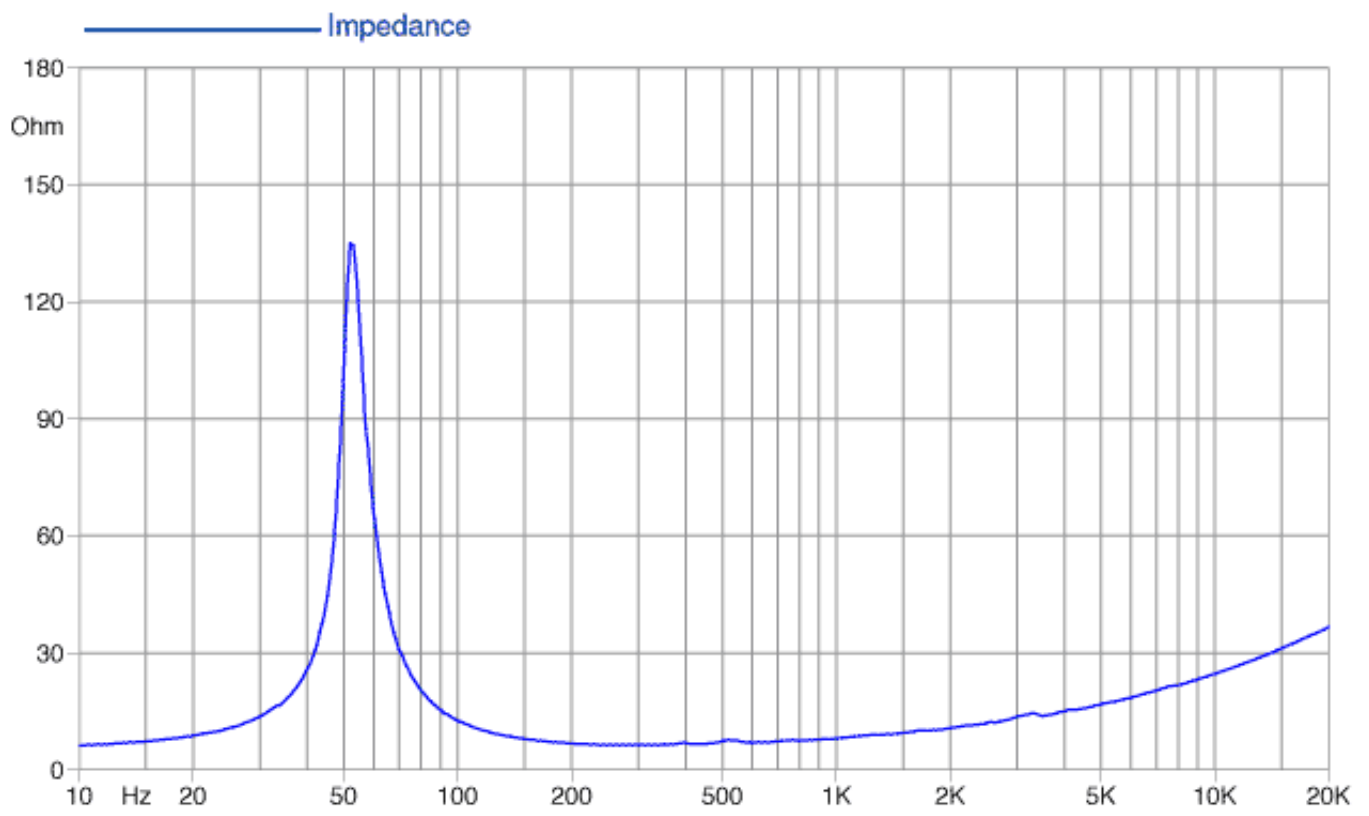

©Copyright 2012 - Faisal S.p.A. Fabbrica Italiana Altoparlanti - All right reserved.