

- 1" voice coil Aluminium former
- Treated silk dome with additional damping treatment
- Ferrofluid in the air gap
- 91.9 dB sensitivity

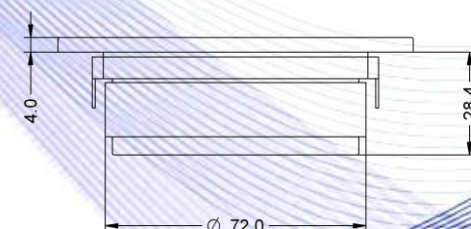

Specifications	
Nominal Diameter	98mm
Nominal Impedance	4Ω
Rated Power AES ⁽¹⁾ (3000 - 20000 Hz)	25W
Continuous Program Power ⁽²⁾	50W
Rated Noise Power (IEC 60268-5) ⁽³⁾	120W
Sensitivity @ 1W/1m ⁽⁴⁾	91.9dB
Voice Coil Diameter	25mm (1")
Voice Coil Winding Depth	1.8mm
Magnetic Gap Depth	2.0mm
Flux Density	1.70T
DC Resistance	3.00Ω
Resonance Frequency	1200Hz
Magnet Weight	245g
Net Weight	0.60kg
Recommended Crossover Frequency	2.5kHz

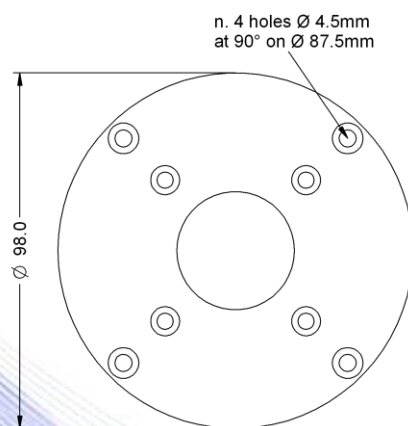

Constructive Characteristics	
Magnet	: Ferrite
Voice Coil Winding Material	: Copper
Voice Coil Former Material	: Aluminium
Diaphragm	: Treated Silk
Ferrofluid in Air Gap	: Yes
Flange	: Aluminium
Spare Part Code	: Z009408

Frequency Response on IEC Baffle (DIN 45575) @ 1W,1m – Free Air Impedance

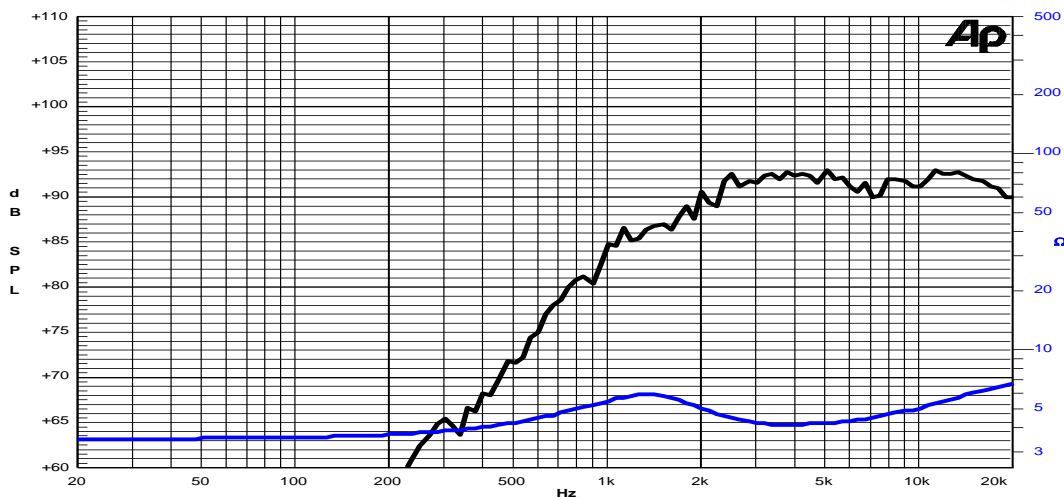

Note:

- 1 : Rated Power measured with 2 hours test with pink noise signal, 6dB crest factor, loudspeaker mounted on enclosure
- 2: Power on Continuous Program is defined as 3 dB greater than the Rated Power
- 3: Rated Noise Power measured with 100 hours test pink noise, 6dB crest factor IFC60268-5 filtering
- 4: Measured at 1W,1m in axis within the frequency range
- 5: Drawing dimensions: mm