

LOWS: Loose/Fat **MIDS:** Subdued **HIGHS:** Smooth **OVERDRIVE:** Edgy

Sound Features:

Guitarist Description:

Add a stylish, sleek bell onto the original Tornado Classic 12, to cover the magnet assembly, for an even better looking speaker, for open back cabinets and combo amplifiers: this is the Tornado Stealth 100, with its original, smooth, refined, yet crystal clear tone. One of the most versatile speakers in the family, and one of the most successful.

Specifications	
Nominal Diameter	307 mm (12")
Nominal Impedance	8 Ω
Rated Power AES ⁽¹⁾	100 W
Continuous Program Power ⁽²⁾	200 W
Sensitivity @ 1W/1m	98.5 dB
Voice Coil Diameter	50 mm
Voice Coil Winding Depth	10 mm
Magnetic Gap Depth	8 mm
Flux Density	1.20 T
Magnet Weight	200 g
Net Weight	2.2 kg

Thiele & Small Parameters ⁽³⁾			
Re	6.81 Ω	Fs	72.0 Hz
Qms	9.51	Mms	29.9 g
Qts	0.52	Bxl	12.93 Tm
Cms	163 μm/N	Sd	490.9 cm ²
Vas	55.9 l	Le (1kHz)	0.70 mH

Constructive Characteristics	
Magnet	Neodymium
Basket Material	Pressed Sheet Steel
Voice Coil Winding Material	Copper
Voice Coil Former Material	Nomex
Cone Material	Paper
Surround Treatment	Yes
Surround Material	Paper - Integrated
Dust Dome Material	Non Treated Cloth

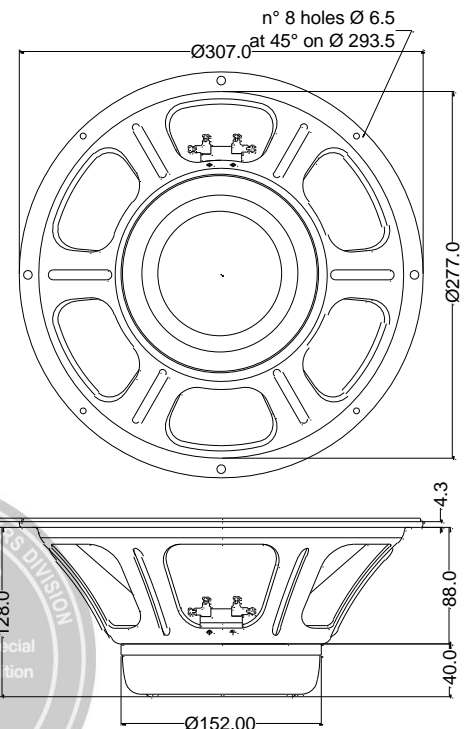
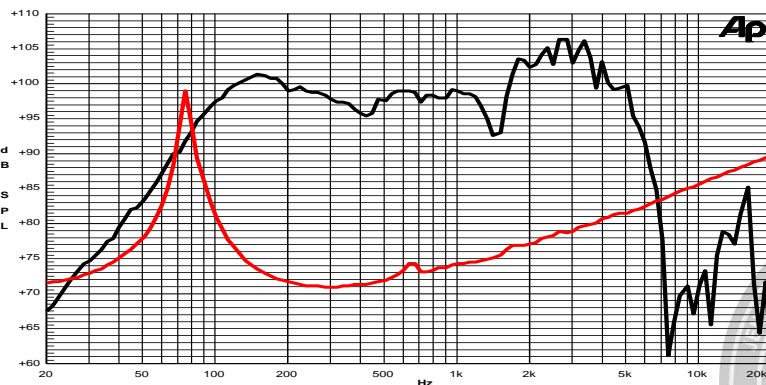

Note:

- 1: Rated Power measured with 2 hours test with pink noise signal, 6dB crest factor, loudspeaker mounted on enclosure
- 2: Power on Continuous Program is defined as 3 dB greater than the Rated Power
- 3: Thiele & Small parameters measured with laser system without preconditioning test
- 4: Drawing dimensions: mm
- 5: The notch around 400Hz on the frequency response is typical of the measurement on IEC baffle